

LH501

Item Code: 07028902

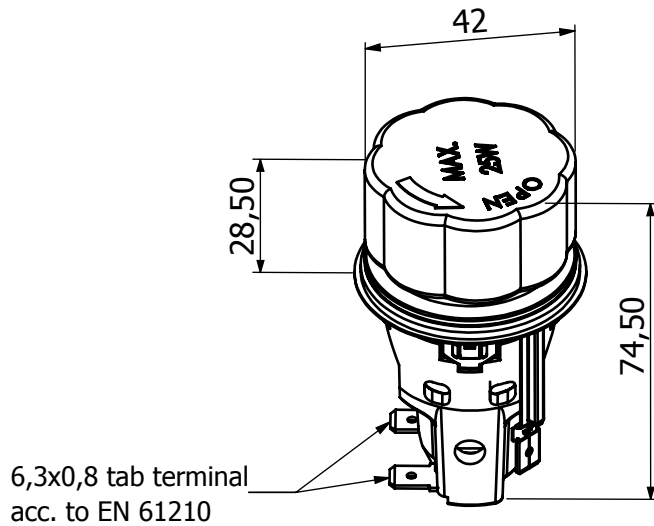

Cut-Out

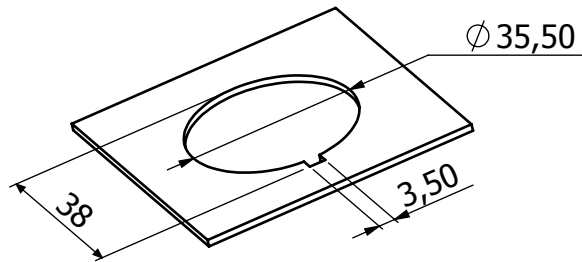

All dimensions in "mm"

Specifications	EN Standards
Application Field	Oven
Nominal Voltage	AC 250V
Nominal Current	2A
Maximum Lamp Wattage	25W
Operating Temperature	T300
Lamp Base / Type	E14 - Incandescent
Approval	Standards
VDE	DIN EN IEC 60238:2019-01 EN IEC 60238:2018+A1:2018