

SIZE 4 – Deep Base: D78mm With & Without 22mm Hole



DE04D-A-GB-0

DE04D-A-BG-4

REGISTERED DESIGN

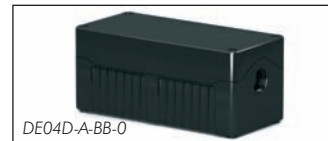

DE04D-A-BB-0

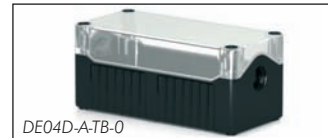

DE04D-A-TB-0

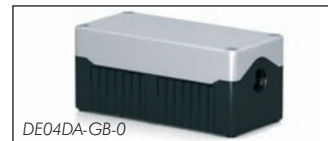

DE04DA-GB-0



DE04D-A-TG-0



DE04D-A-GG-0

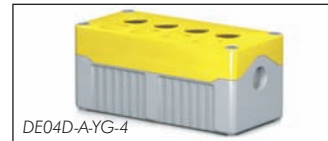

DE04D-A-YG-4

DE04D ENCLOSURES

- Deep Base: H80 x W172 x D78mm
- Materials: Flame retardant ABS UL94-HB (A), ABS UL94-V0 (V) (non-standard) or Polycarbonate UL94-V0 (P)
- Colours – Base: Black (B) or grey (G)
Cover With Hole: Black (B)**, grey (G) or yellow (Y)
Without Hole: Black (B), grey (G) or transparent (T)
- Sealed up to IP67
- 4x PCB M3 self-tapping mounting feet
- Complete with 2x M20 threaded and 2x M20 non-threaded knockouts
- 14x vertical PCB mounting slots
- Snap-on flange and din rail brackets
- With hole suitable for 4x contact blocks per switch

NEW Snap-on Brackets*



*REGISTERED DESIGN



DE04D-A-GG-4



DE04D-A-YB-4

** Photos of DE04D-A-BB-4 and DE04D-A-BG-4 not shown.

DE04D WITH HOLE & WITHOUT HOLE

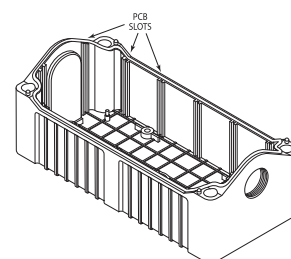
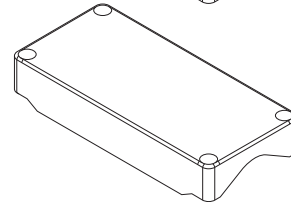
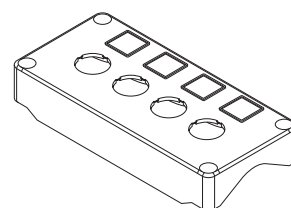
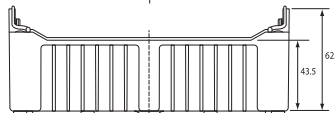
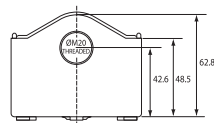
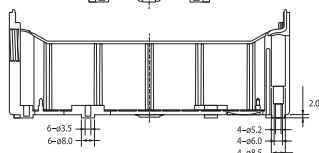
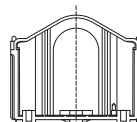
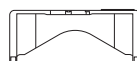
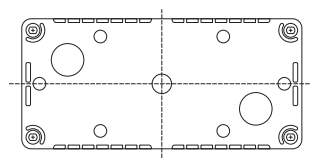
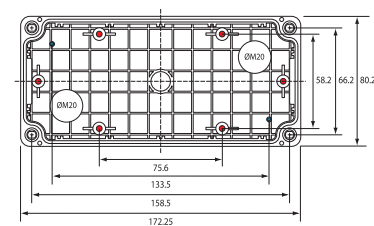
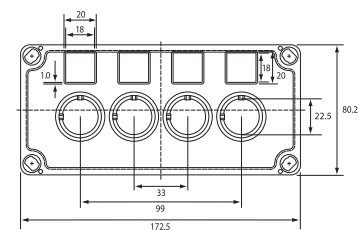

KEY
● = SELF TAPPING ● = LOCATION STUD

The unique solution to protect and house electronic components and control switches.

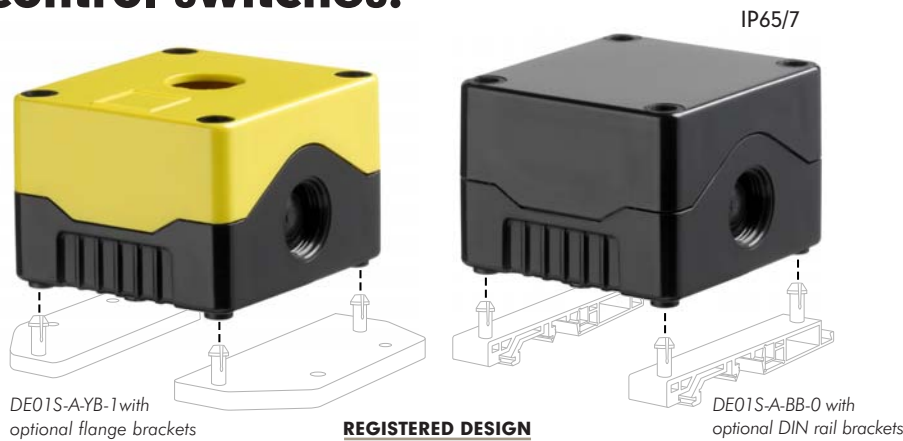

This unique range of robust, sealed enclosures have been specially designed and manufactured for use in the electrical and electronic engineering markets.

MAIN FEATURES

- Sealed up to IP67
- Unique snap-on DIN rail and flange brackets
- Dust and waterproof for short-term submersion with integrated moulded seals
- Available in three flame retardant materials: Polycarbonate – UL94-V0 for improved resistance to shock, ABS – UL94-HB and ABS – UL94-V0
- 2x threaded M20 cable entry and knockout – premoulded area that can be pushed out for use only with M20 size male cable gland
- Additional non-threaded M20 knockout on base
- Captive plastic screws to lid fixing for corrosion resistant, increase torque and insulation
- Elongated integral chassis fixing holes retaining IP67
- Common threaded hole mounts cover to base and base to chassis
- Accepts both "D" and location lug for push button barrels
- Selector and key switches can be mounted centre or at 90°
- Available with and without 22mm holes suitable for standard control switches and indicators

- PCB mounting posts and slots as standard
- 2x PCB mounting location studs
- 8-22x vertical PCB mounting slots, as standard
- 4-8x self-tapping screw fixings for mounting PCB
- 10 sizes available, with hole and without hole accepting 1 to 6 push button switches
- All bases available in two depths, 53mm and 78mm
- Standard base with only 47mm internal depth measurement
- Standard base suitable for 2x contact blocks per switch
- Deep base suitable for 4x contact blocks per switch

3 Mounting Options:

- 4x elongated integral mounting holes
- Snap-on chassis mounting flange
- Snap-on DIN rail mounting brackets

Colours:

- Base: Black (B) or grey (G)
- Cover With Hole: Black (B), grey (G) or yellow (Y)
- Cover Without Hole: Black (B), grey (G) or transparent (T)
- Additional colours available

1ST IN THE WORLD

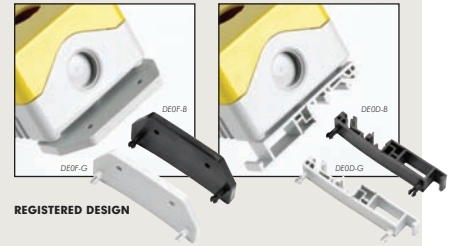

The world's first range of enclosures with unique snap-on flange and DIN rail brackets!

ORDERING INFORMATION

DE 01 S - A - Y B - 1	
Size	01 = 80 x 73 x base 02 = 80 x 106 x base 03 = 80 x 139 x base 04 = 80 x 172 x base 06 = 80 x 238 x base
Base	S = Standard Base: 53mm D = Deep Base: 78mm
Material	A = ABS - UL94-HB V = ABS - UL94-V0 P = Polycarbonate - UL94-V0
Cover Colour	B = Black G = Grey T = Transparent Y = Yellow
Base Colour	B = Black G = Grey
No. Holes	0 = Without holes 1 = 1 hole 2 = 2 holes 3 = 3 holes 4 = 4 holes 5 = 5 holes 6 = 6 holes

Example
DE01S-A-YB-1 = Size 1, standard base, ABS material, yellow cover, black base with one hole.

To order or ask for more information...

Telephone: **08456 187709**, or
Fax: 02084 455612 or send an
Email to info@decontrols.co.uk

ACCESSORIES

- Wall mounting brackets
- Combi foot - TS32 and TS35 DIN rail mounting clip
- M20 cable glands for use in knock-outs
- Component mounting bracket