

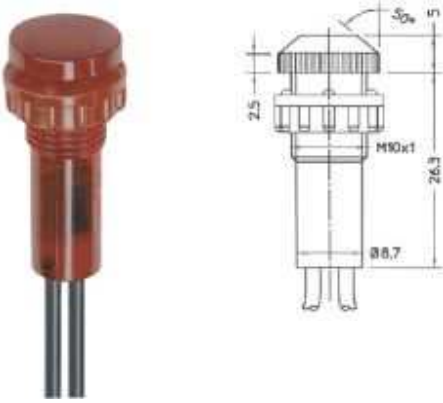

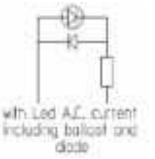

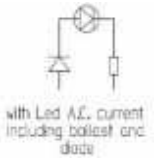



## Signal lights: Signal lights Cut-out Ø 8-10 | SX31

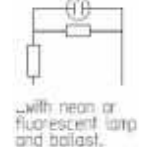
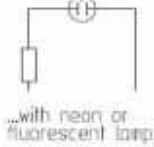

**Hole** Ø 10  
**Panel thickness** 0.5 - 9.0 mm

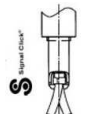
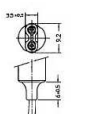

Wiring diagrams	Approvals	Connections
 <p>with Led A.C. current including ballast and diode</p>  <p>with Led A.C. current including ballast and diode</p>  <p>with Led D.C. current or A.C. low voltage including ballast.</p>  <p>with incandescent lamp.</p>  <p>with neon or fluorescent lamp and ballast.</p>  <p>with neon or fluorescent lamp.</p>	  	   

**Temperature:** From T75° C to T150° C according to the version

**Colour:** Red, orange, green, blue, colourless. Other colours available on customer's request

**Wire ends and connectors:** PVC or silicone cables, available pre-stripped wires end 6.5 mm or with clamped connectors

**Light source :** LED: available for every voltage;

Incandescence: 12V - 24V;

Neon: from 125V.

Stampa scheda