

PERFECT cable gland

50.6xx PAzzzz

| | |
|-------------------|---------------------------------------|
| Dome nut | Polyamide PA6 V-2 |
| Sealing ring | Polychloroprene-Nitrile rubber CR/NBR |
| Gland body | Polyamide PA6 V-2 |
| Connecting thread | metric, as per EN 60423 |



Properties

| | |
|------------------------|--|
| | <ul style="list-style-type: none"> integrated anchorage wide sealing and clamping range easy-to-install |
| Temperature range (°C) | -20°C / +100°C (dynamic) -40°C (static, short term) |
| Protection grade | 68 5 |
| Test standard | EN 50262 UL 514B |
| VDE licence | 40020902 |
| UL / CSA-File | E140310 |
| GL T.A. Certificate | 44 608 - 07 HH |
| Comment | details about tests - see annex |

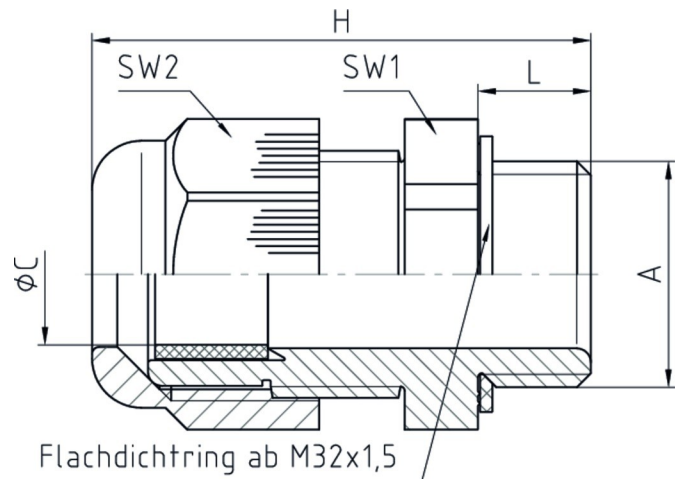

Features

 RAL 9005

Connecting thread standard length

| A | ØC | L | SW1 | SW2 | H |  | Part No. |
|---------|---------|----|-----|-----|------|--|--------------|
| M12x1,5 | 3 - 6 | 8 | 15 | 15 | 31 | 100 | 50.612 PA/SW |
| M16x1,5 | 5 - 10 | 8 | 20 | 20 | 35,5 | 100 | 50.616 PA/SW |
| M20x1,5 | 8 - 13 | 8 | 24 | 24 | 36 | 100 | 50.620 PA/SW |
| M25x1,5 | 11 - 17 | 8 | 29 | 29 | 43 | 50 | 50.625 PA/SW |
| M32x1,5 | 15 - 21 | 10 | 36 | 36 | 50 | 25 | 50.632 PA/SW |
| M40x1,5 | 19 - 28 | 10 | 46 | 46 | 51 | 10 | 50.640 PA/SW |
| M50x1,5 | 27 - 35 | 12 | 55 | 55 | 61,5 | 5 | 50.650 PA/SW |
| M63x1,5 | 32 - 42 | 12 | 68 | 68 | 65,5 | 5 | 50.663 PA/SW |

Connecting thread long

| A | ØC | L | SW1 | SW2 | H |  | Part No. |
|---------|---------|----|-----|-----|------|--|---------------|
| M12x1,5 | 3 - 6 | 15 | 15 | 15 | 38 | 100 | 50.612 PA/SWL |
| M16x1,5 | 5 - 10 | 15 | 20 | 20 | 42,5 | 100 | 50.616 PA/SWL |
| M20x1,5 | 8 - 13 | 15 | 24 | 24 | 43 | 100 | 50.620 PA/SWL |
| M25x1,5 | 11 - 17 | 15 | 29 | 29 | 50 | 50 | 50.625 PA/SWL |
| M32x1,5 | 15 - 21 | 15 | 36 | 36 | 55 | 25 | 50.632 PA/SWL |
| M40x1,5 | 19 - 28 | 18 | 46 | 46 | 59 | 10 | 50.640 PA/SWL |
| M50x1,5 | 27 - 35 | 18 | 55 | 55 | 67,5 | 5 | 50.650 PA/SWL |
| M63x1,5 | 32 - 42 | 18 | 68 | 68 | 71,5 | 5 | 50.663 PA/SWL |



RAL 7035

Connecting thread standard length

| A | ØC | L | SW1 | SW2 | H |  | Part No. |
|---------|---------|----|-----|-----|------|--|---------------|
| M12x1,5 | 3 - 6 | 8 | 15 | 15 | 31 | 100 | 50.612 PA7035 |
| M16x1,5 | 5 - 10 | 8 | 20 | 20 | 35,5 | 100 | 50.616 PA7035 |
| M20x1,5 | 8 - 13 | 8 | 24 | 24 | 36 | 100 | 50.620 PA7035 |
| M25x1,5 | 11 - 17 | 8 | 29 | 29 | 43 | 50 | 50.625 PA7035 |
| M32x1,5 | 15 - 21 | 10 | 36 | 36 | 50 | 25 | 50.632 PA7035 |
| M40x1,5 | 19 - 28 | 10 | 46 | 46 | 51 | 10 | 50.640 PA7035 |
| M50x1,5 | 27 - 35 | 12 | 55 | 55 | 61,5 | 5 | 50.650 PA7035 |
| M63x1,5 | 32 - 42 | 12 | 68 | 68 | 65,5 | 5 | 50.663 PA7035 |

Connecting thread long

| A | ØC | L | SW1 | SW2 | H |  | Part No. |
|---------|---------|----|-----|-----|------|--|----------------|
| M12x1,5 | 3 - 6 | 15 | 15 | 15 | 38 | 100 | 50.612 PA7035L |
| M16x1,5 | 5 - 10 | 15 | 20 | 20 | 42,5 | 100 | 50.616 PA7035L |
| M20x1,5 | 8 - 13 | 15 | 24 | 24 | 43 | 100 | 50.620 PA7035L |
| M25x1,5 | 11 - 17 | 15 | 29 | 29 | 50 | 50 | 50.625 PA7035L |
| M32x1,5 | 15 - 21 | 15 | 36 | 36 | 55 | 25 | 50.632 PA7035L |
| M40x1,5 | 19 - 28 | 18 | 46 | 46 | 59 | 10 | 50.640 PA7035L |
| M50x1,5 | 27 - 35 | 18 | 55 | 55 | 67,5 | 5 | 50.650 PA7035L |
| M63x1,5 | 32 - 42 | 18 | 68 | 68 | 71,5 | 5 | 50.663 PA7035L |



RAL 7001

Connecting thread standard length

| A | ØC | L | SW1 | SW2 | H |  | Part No. |
|---------|---------|----|-----|-----|------|--|---------------|
| M12x1,5 | 3 - 6 | 8 | 15 | 15 | 31 | 100 | 50.612 PA7001 |
| M16x1,5 | 5 - 10 | 8 | 20 | 20 | 35,5 | 100 | 50.616 PA7001 |
| M20x1,5 | 8 - 13 | 8 | 24 | 24 | 36 | 100 | 50.620 PA7001 |
| M25x1,5 | 11 - 17 | 8 | 29 | 29 | 43 | 50 | 50.625 PA7001 |
| M32x1,5 | 15 - 21 | 10 | 36 | 36 | 50 | 25 | 50.632 PA7001 |
| M40x1,5 | 19 - 28 | 10 | 46 | 46 | 51 | 10 | 50.640 PA7001 |
| M50x1,5 | 27 - 35 | 12 | 55 | 55 | 61,5 | 5 | 50.650 PA7001 |
| M63x1,5 | 32 - 42 | 12 | 68 | 68 | 65,5 | 5 | 50.663 PA7001 |

Connecting thread long

| A | ØC | L | SW1 | SW2 | H |  | Part No. |
|---------|---------|----|-----|-----|------|---|----------------|
| M12x1,5 | 3 - 6 | 15 | 15 | 15 | 38 | 100 | 50.612 PA7001L |
| M16x1,5 | 5 - 10 | 15 | 20 | 20 | 42,5 | 100 | 50.616 PA7001L |
| M20x1,5 | 8 - 13 | 15 | 24 | 24 | 43 | 100 | 50.620 PA7001L |
| M25x1,5 | 11 - 17 | 15 | 29 | 29 | 50 | 50 | 50.625 PA7001L |
| M32x1,5 | 15 - 21 | 15 | 36 | 36 | 55 | 25 | 50.632 PA7001L |
| M40x1,5 | 19 - 28 | 18 | 46 | 46 | 59 | 10 | 50.640 PA7001L |
| M50x1,5 | 27 - 35 | 18 | 55 | 55 | 67,5 | 5 | 50.650 PA7001L |
| M63x1,5 | 32 - 42 | 18 | 68 | 68 | 71,5 | 5 | 50.663 PA7001L |

with sealing ring and O-ring made of FKM on request